



Installation Instructions

Power Disc Brake Conversion Kit

Item # FC0001-H405A

Applications: 1964.5-66 Mustang

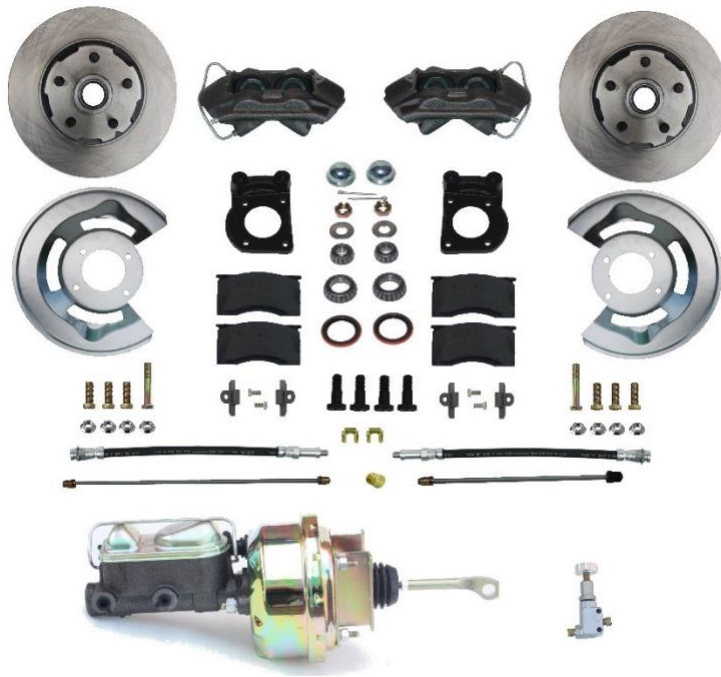

Thank you for choosing Leed Brakes for your automotive product needs. Before you begin your installation please inspect all parts and review the installation instructions. If you have any missing or damaged parts or if you have any questions regarding the fitment of this kit on your specific vehicle please contact our customer service team at (716) 852-2139 before beginning your installation

Tools required for a safe and smooth installation:

Proper Jack & Jack Stands, Tube Wrenches, Standard Socket Set, Standard Wrench Set, Torque Wrench, Lug Wrench, Pliers, Mallet, Brake Fluid, Brake Cleaner, Wheel Bearing Grease.

Fitment Notes:

This kit is designed to fit 64.5 to 66 V8 5-Lug drum brake cars. This kit is also a direct replacement for all factory disc brake cars from 1965-1966 equipped with Kelsey Hayes 4 Piston Calipers.

Drum Brake Removal:

1. Safely raise the vehicle off the ground until the wheels are clear and spin freely. Support the vehicle using the appropriate Jack Stands and remove the front wheels.
2. Starting at the front wheel hub, remove the grease cap, cotter pin, lock nut and flat washer from the spindle as well as the outer bearing.
3. You should now be able to slide the hub/drum assembly off the spindle. If you have trouble removing this assembly you may need to retract the brake shoes by inserting a flathead screwdriver into the adjustment slot in the drum brake backing plate. Use the screwdriver to disengage the adjusting lever from the adjusting screw. You should now be able to turn the adjusting screw to retract the brake shoes.
4. Before you remove the drum brake backing plate you will want to remove all brake fluid from your brake system. ***Be very careful not spill any brake fluid on any painted surfaces as it will damage your paint.*** To remove the brake fluid from your system first remove the lid from your master cylinder. Next place one end of a clear hose on the bleeder of your wheel cylinder and the other into a suitable container. Finally open the bleeder screw until all fluid has been removed from your system
5. From under the dash disconnect the pushrod from the pedal assembly.
6. Disconnect the brake line(s) from your master cylinder. Remove the retaining hardware and remove the master cylinder and or power booster from the firewall. This assembly will also include the pushrod that was previously disconnected from the pedal.
7. Disconnect the hard brake line from your flexible hose at the frame rail. It is recommended you use a tube wrench as to not damage the brake line fittings. If your fittings look rusty spray them with penetrating oil and let them soak for easy removal.
8. Remove the horseshoe clip from the brake hose at the frame mount.
9. Remove the drum brake backing plate assembly by removing the 4 retaining bolts and nuts attaching it to your spindle. Again the use of penetrating oil is recommended on any rusty hardware for easy removal.

Inspection:

Once you have removed all drum brake components from your spindles it is recommended that you clean your spindles bearing surfaces. Check for any debris or signs of damage to the spindle. Any light damage caused by rust can usually be cleaned up with an emery cloth.

At this point you should also test install your new bearings onto the spindle to ensure proper fitment without interference. Photo 3

Brake Kit Installation:

1. The calipers will be installed on the front side of the spindle. Install **Caliper mounting brackets** so that the caliper mounting bosses face the inside of the vehicle and are orientated towards the front of the car. **Photo 1**
2. The splash shields will be installed on top of the mounting brackets. Install the **splash shield** so that the opening for the caliper faces the front of the car and the splash shield is recessed to the inside of the car. **Photo 2**
3. Attached the splash shield and caliper mounting bracket using the **3/8" bolts & locknuts** supplied in the kit. You will use 3 of the shorter bolts and 1 long bolt on either side of the car. The longer bolt will be use in the hole that passes thru the steering arm. The 3 shorter bolts will be installed in the remaining holes. Install the bolts so that the locknuts are installed towards the inside of the vehicle. Once you have secured the bolts with the locknuts, torque to 35-45 ft. lbs.
4. Next you will need to properly pack the **inner and outer bearings** with grease prior to installation.
5. Remove the protective coating from your **rotors** on both the braking surface and bearing race surfaces using a brake cleaner available at your local parts store.
6. Install the greased **inner bearing** into the inner race of the **rotor**. **Photo 4**
7. Lightly pack grease into the inner lip of the **grease seal**. Next install the **grease seal** into the inner portion of the **rotor** using a soft mallet or piece of wood. This will prevent any damage from occurring during installation. * **The lip of the seal should face the bearing when installed. Photo 5**
8. Slide the **rotor** onto the **spindle** and install the greased **outer bearing, slotted washer** and **adjusting nut. Photo 6 and 7**
 - a. **Proper adjustment of the bearings is VERY IMPORTANT.** Rotate the rotor while tightening the spindle nut to 18-24 ft lbs. Next back off the adjustment nut about 1/2 turn and retighten to 10-15 ft lbs while aligning the retaining slots with the cotter pin hole in the spindle.
 - b. Install **cotter pin**, bend cotter pin so that each side is bent in the opposite direction of the other. **c.** Install the **grease cap. Photo 8**
 - d. Spin the rotor to insure there is no interference with the grease cap and retaining assembly.
9. **Calipers** should arrive preloaded, if they are not you must install the brake pads so that the friction material is facing each other. Next install the metal retaining clips using the 1/4" bolts and lock washers supplied. Torque to 7-11 ft lbs. **Photo 9**
10. Install the **calipers** with the bleeder facing up. Use the **7/16-14 x 1-5/8" shoulder bolts** provided. Torque to 4560 ft. lbs. If the caliper interferes with the splash shield minor trimming of the splash shield may be required, see last page for reference. **Photo 10 and 11**
11. Once the calipers are installed spin the rotors to insure there is no interference between the caliper and the rotor.
12. Install the **flex hose** to the **caliper** using (1) **copper washer** between the hose fitting and the caliper. **Photo 12**

13. Install the other end of the flex hose to the frame bracket and retain it using the **horseshoe clip** provided. Reconnect the original hard line and tighten using a tube wrench.
14. Turn the wheels thru a complete left and right turn to insure there is no interference with the new brake system and any suspension or body components. Also check the rubber hoses during this operation to insure the hoses are not binding or twisting. If your rubber hoses bind during a turn you could experience loss of braking while driving. If it looks like they are binding remove the horseshoe clip and reposition the brake hose until it no longer binds.
15. If needed install the **brass brake line adapters** provided into the rubber hose and connect your factory hard brake line. Not all cars will need these adapters, if your car is equipped with a 3/8-24 fitting on your hard line you can install your hard line directly to the brake hose.

Power Booster Installation

1. Remove the steel brake line going from the original master cylinder to the factory distribution block.
2. Disconnect the rear brake line from the distribution block and plug that port with the **3/8-24 plug** provided.
3. Install the brass fittings provided into the **Adjustable Proportioning Valve** and tighten.
4. Install the **Adjustable Proportioning Valve** to the rear brake line, the "**out**" port of the adjustable valve will be used here.
5. Install the **new push rod** onto the power booster, do not lock it into position yet as adjustments will need to be made later.
6. With the booster **check valve positioned** in the upper RH corner, install the power booster **mounting brackets** so that the longer leg of the bracket is at the bottom of the booster.
7. Secure power booster to firewall using the original mounting bolts. These bolts may be difficult to tighten with the limited space available. All 4 bolts can be accessed using a standard wrench.
8. From under the dash **adjust the pushrod** to meet the pedal in its original position. Once the pushrod has met the desired length, secure the **locking nut** to the pushrod.
9. Install original pushrod locking mechanism to secure the pushrod to the pedal.
10. Use a **vacuum hose** to connect the power booster to a direct source of engine manifold vacuum or aftermarket vacuum pump.
11. Verify that your brake light switch is adjusted correctly so that the tail lights turn on and off as the brake pedal is depressed and released. If you have an early car with the hydraulic brake light switch may require an additional adapter fitting to re-install the pressure switch for the brake lights. These adapters are available thru most Mustang parts sources.

Master Cylinder Bench Bleeding

1. Before you install your master cylinder you must **bench bleed** it in a vice off of the vehicle using the **bench bleeder kit** provided.
2. To Bench Bleed
 - a. Place your master cylinder in a **vice** by the mounting ears.
 - b. Attach a clear plastic hose to the short end of each of the plastic nozzles provided.

- c. Clip the plastic bridge onto the partition wall of the master cylinder and insert each plastic tube into the holes insuring the end of the tube will be fully submerged in the brake fluid.
- d. Press the tapered end of the nozzles firmly into the master cylinder ports with a twisting motion.
- e. Fill the reservoir with new clean brake fluid (DOT 3 or DOT 4 Recommended).
- f. Using a large Phillips head screwdriver push the piston in, then release using full strokes. This MUST be done until ALL air has disappeared from the clear plastic hoses.

CAUTION- MASTER CYLINDER WILL NOT BLEED PROPERLY IF HOSES ARE NOT FULLY SUBMERGED IN BRAKE FLUID UNTIL THE BLEEDING PROCESS IS COMPLETE

Master Cylinder Install:

1. Remove the master cylinder from the vice and install on the booster, secure with the provided hardware. ***Be very careful not spill any brake fluid on any painted surfaces as it will damage your paint.***
2. Carefully remove the bleeder kit nozzles and install the brake lines in the appropriate ports.
3. Install the brake line with the ½" fitting to the port for the rear brakes (port furthest from the firewall) and connect the other end to the "IN" port of the **adjustable proportioning valve.**
4. Install the brake line with the (2) 3/8" fittings into the front brake port (port closest to the firewall) and connect the other end to the open port in the factory distribution block.
5. Secure all brake lines and check for leaks.

Bleeding the vehicles braking system:

We recommend that the brake system is bled using a gravity bleed method. While there are many ways to bleed a system this way is less likely to introduce air in the system causing a spongy pedal. Whenever bleeding your system you must keep an eye on your fluid level. If your master runs dry you will have to bench bleed the master again.

1. Remove the cap from the master cylinder.
2. Starting at the right rear wheel cylinder or caliper attach a clear hose to the bleeder with the other end in a clear container.
3. Open the bleeder and observe the fluid flow. It may take a couple of minutes for the fluid to flow with a new system. Once the fluid begins to flow let it drip until you do not see any air.
4. Move to the left rear wheel, repeat step 3.
5. Move to the right front wheel, repeat step 3.
6. Move to the left front wheel, repeat step 3.
7. Repeat steps 2 thru 6 once more.
8. Install the lid on the master cylinder.
9. Pump the brake pedal until you achieve a firm pedal.
10. Remove lid on master cylinder & check fluid level
11. Repeat steps 2 thru 6 to insure all air has been removed.

Adjustable Proportioning Valve Adjustment

1. The adjustable proportioning valve is meant to control rear brake lockup by limiting the pressure to the rear brakes. If the rear brakes lockup prematurely the car can be difficult to control during a hard stop.
2. The valve provides a maximum of a 55% reduction in rear brake pressure. Meaning that even when adjusted to the full decrease position it will not shut off the rear brakes. Count the turns from the full decrease position to the full increase position. Turn the knob back in the full decrease direction half that number of turns. This will give you a good starting point for most vehicles.
3. Once you are confident that the brakes are fully bleed, working properly and broken in you can make several stops in a safe open area to determine your ideal setting. The goal is to provide as much pressure as possible to the rear brakes without locking them up prior to the front brakes.

Once you feel you have successfully removed all air from your brake system check all fittings and lines for leaks and verify all fasteners are tight. Install your wheels, and spin them to insure they still spin freely making sure the caliper doesn't interfere with the wheel and your brakes are not dragging or locked up.

You may now take your vehicle for a test drive in a safe area. We recommend that you drive the vehicle with light to medium application of the brakes for the first 150-200 miles. This will allow your brake pads to properly seat to your rotors to insure optimal braking performance.

If you have any questions please call our tech line at (716) 852-2139

Thank you for purchasing from Leed Brakes we hope you have had an enjoyable experience.

Splash Shield Interference Reference Guide

From time to time we experience an interference issue between the caliper and the splash shield. It is understood that this was an issue on the assembly line with the factory disc brake cars as well. If you do experience interference with your caliper and splash shield please modify the splash shield as outlined below





Installation Photos

Disc Brake Conversion Kit

Applications: 67-73 Mustang, 67-69 Falcon, 67-69 Fairlane, Ranchero, Comet, Cyclone, 67-73 Cougar, 68-71 Torino, Montego



← Front of Car

Photo 1

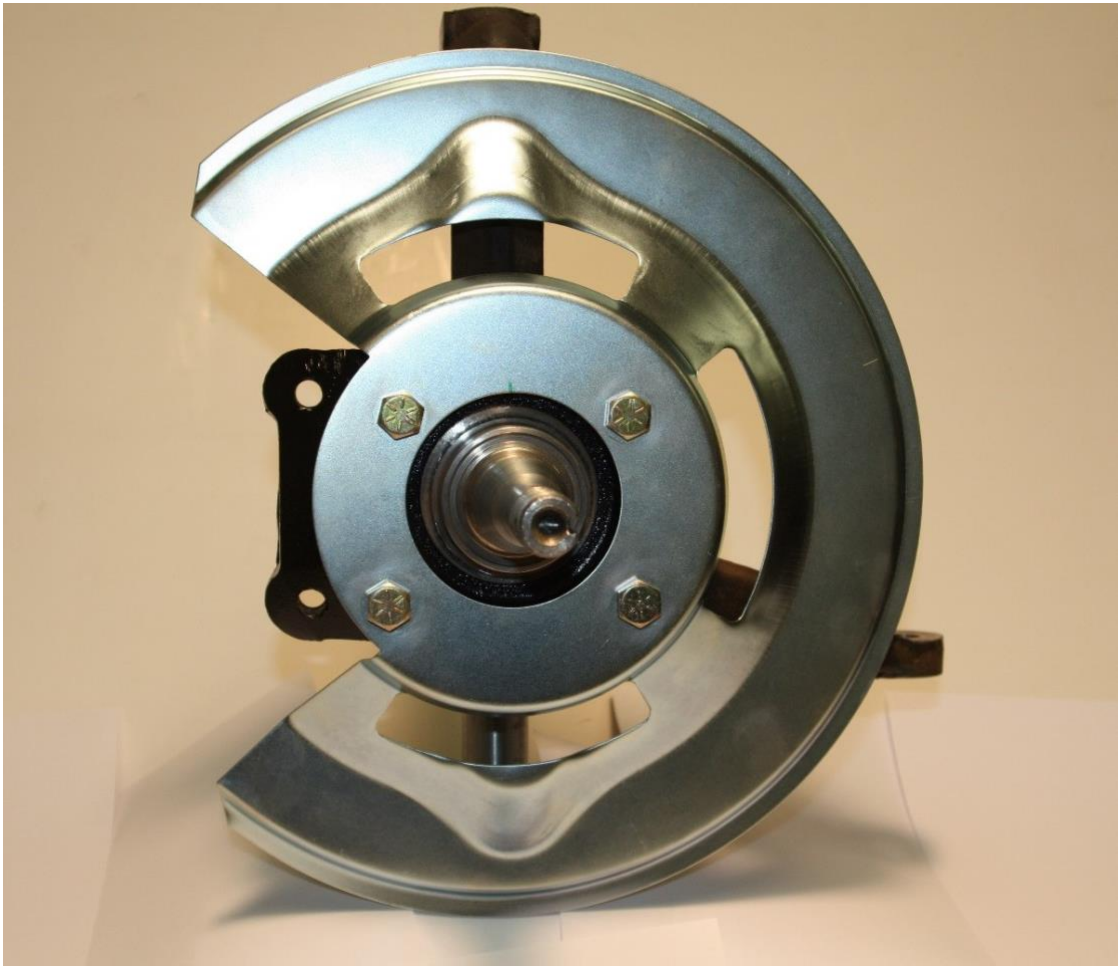

Photo 2

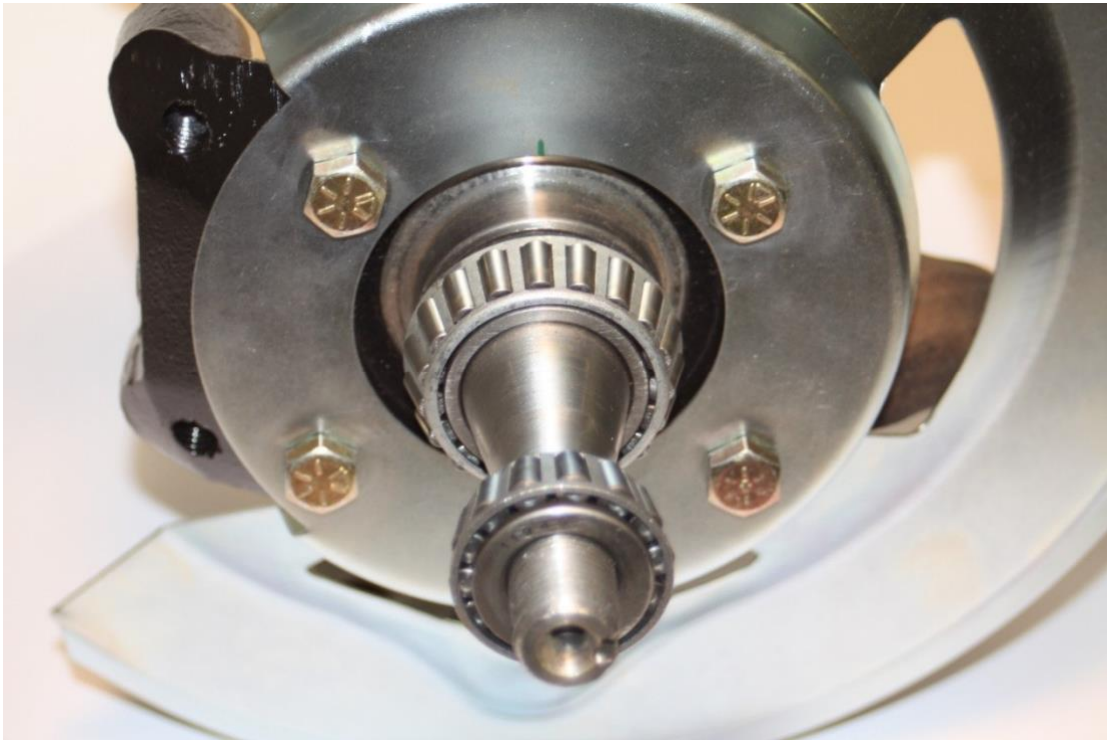

Photo 3



Photo 4

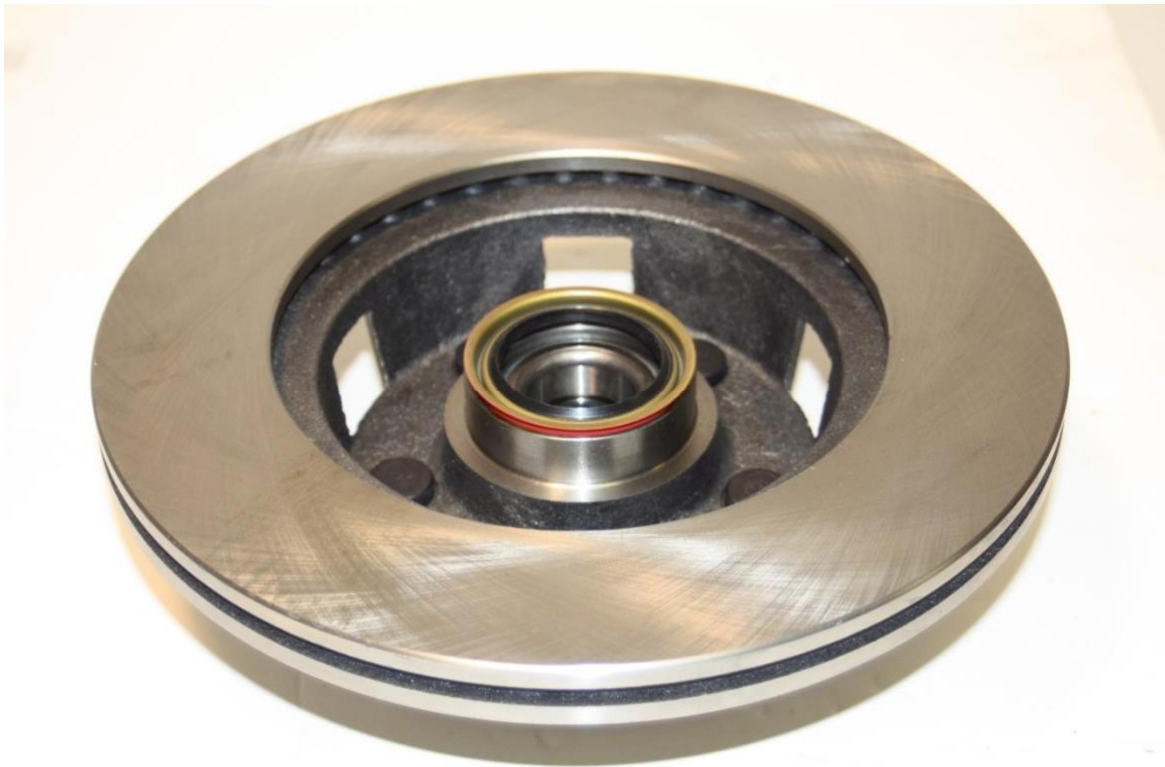

Photo 5



Photo 6



Photo 7



Photo 8

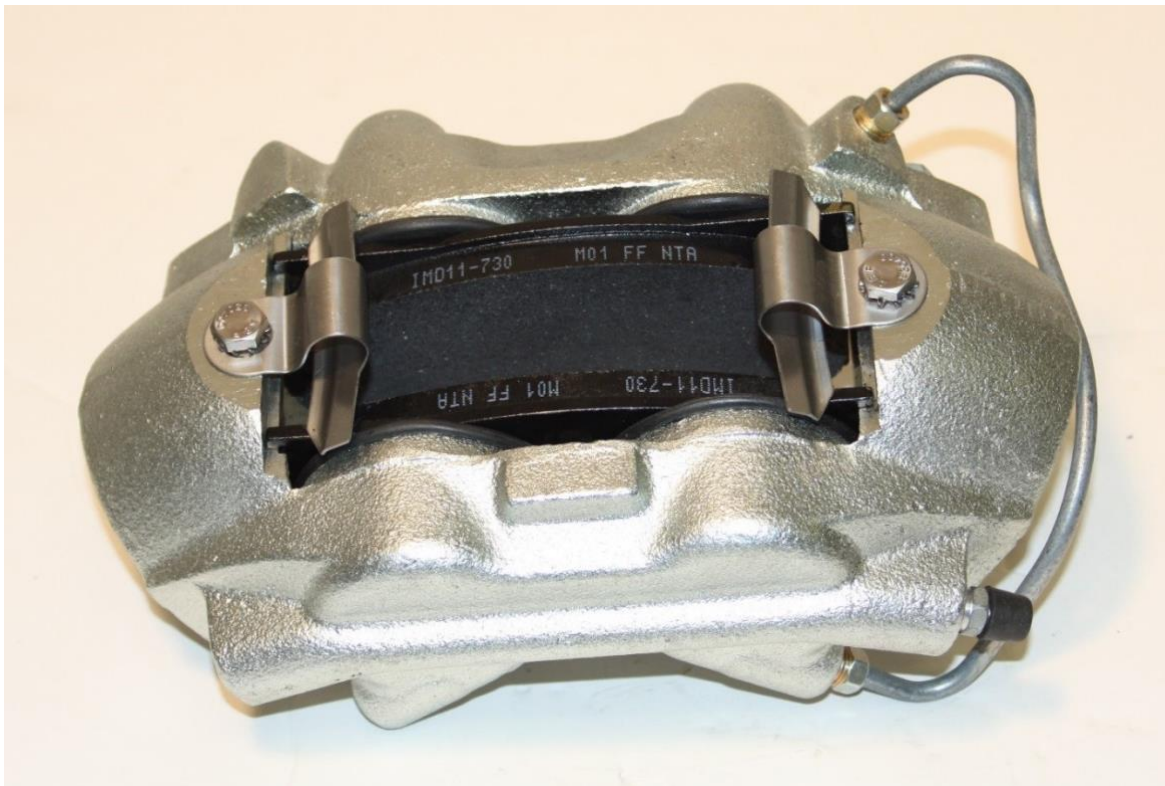
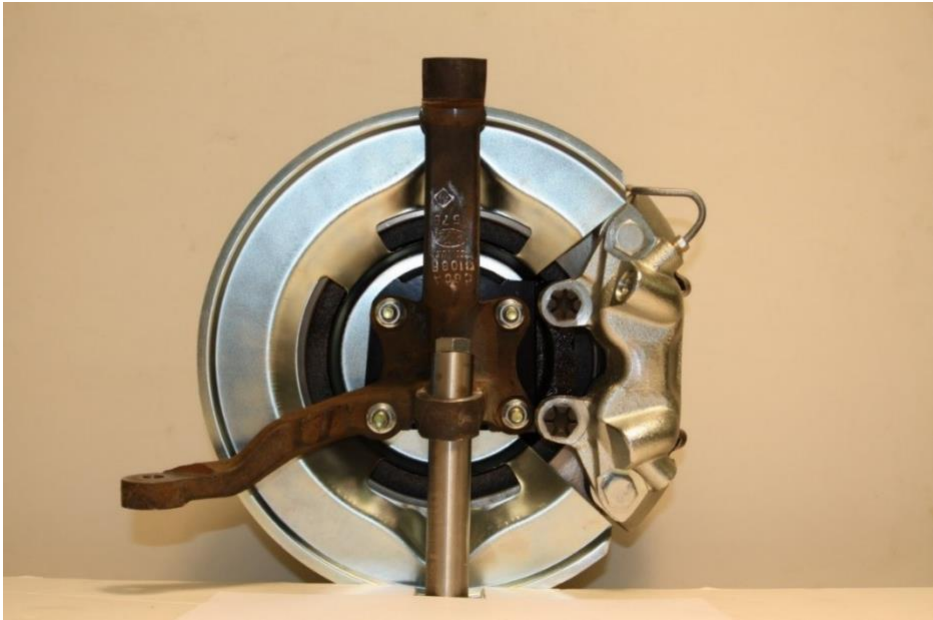

Photo 9



← Front of Car

Photo 10



Front of car→

Photo 11

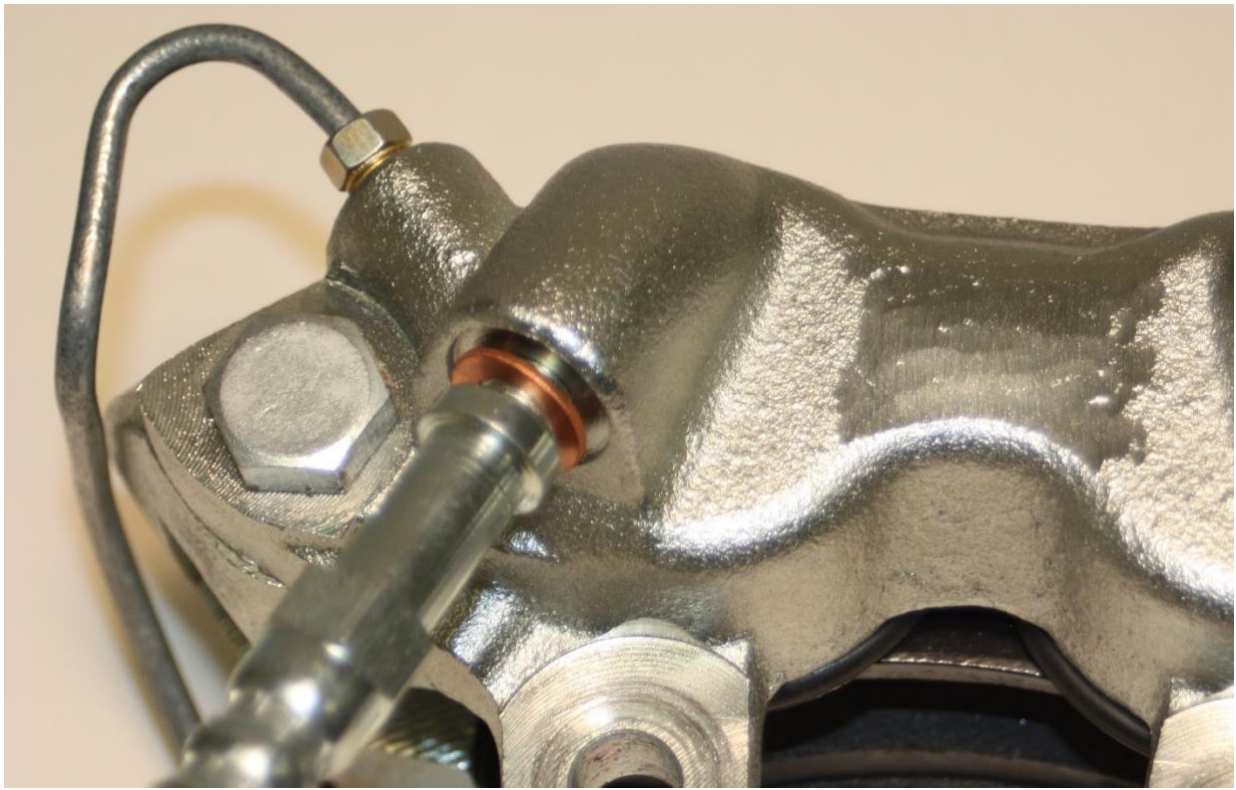

Photo 12