



Installation Instructions

Power Disc Brake Conversion Kit

Item # FC1002 Series & FC1006 Series

Applications: 64-72 GM A Body, 67-69 F-Body, 68-74 X-Body, 62-67 Nova

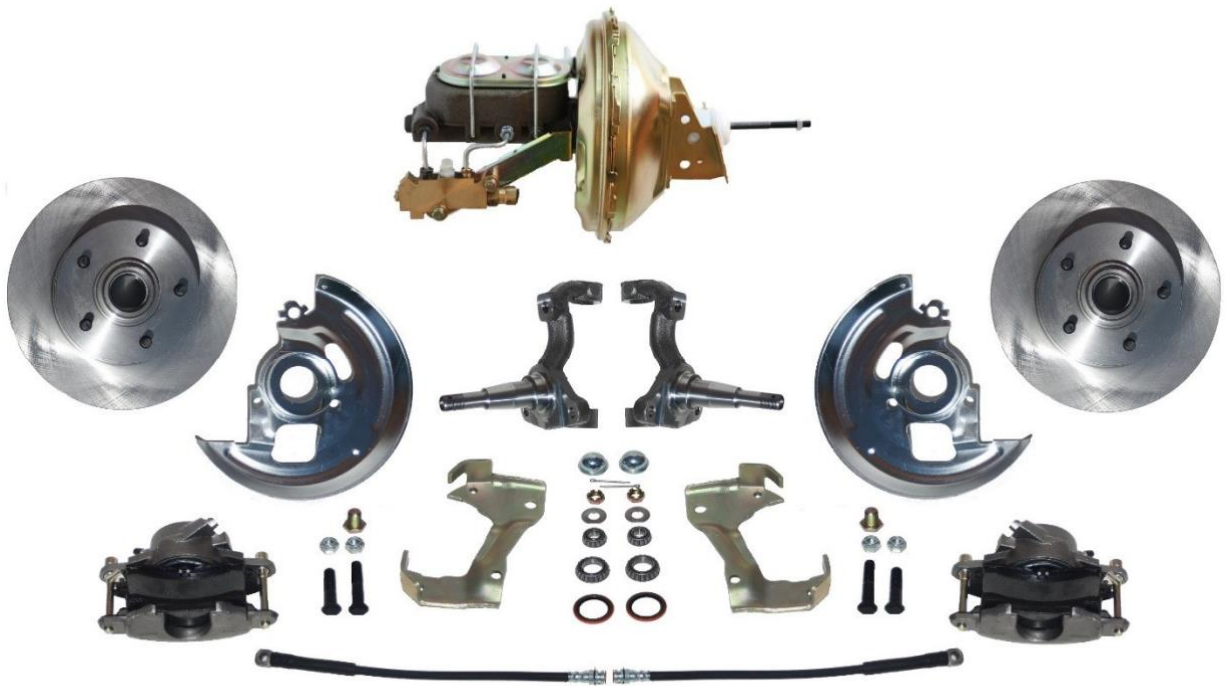

Thank you for choosing Leed Brakes for your automotive product needs. Before you begin your installation please inspect all parts and review the installation instructions. If you have any missing or damaged parts or if you have any questions regarding the fitment of this kit on your specific vehicle please contact our customer service team at (716) 852-2139 before beginning your installation.

Tools required for a safe and smooth installation:

LEED Brakes • 3248 Union Rd. Cheektowaga, NY 14227 • (716)852-2139 • www.LEEDBrakes.com

INS0003

Proper Jack & Jack Stands, Tube Wrenches, Standard Socket Set, Standard Wrench Set, Separator or "pickle fork", Torque Wrench, Lug Wrench, Pliers, Mallet, Brake Fluid, Brake Cleaner, Wheel Bearing Grease.

1962-64 Chevy II with 4 Lug wheels will require the use of steering arms from a 1965-67 Nova equipped with a V8 and 5 lug wheels.

Drum Brake Removal:

1. Safely raise the vehicle off the ground until the wheels are clear and spin freely. Support the vehicle using the appropriate Jack Stands and remove the front wheels.
2. Starting at the front wheel hub, remove the grease cap, cotter pin, lock nut and flat washer from the spindle as well as the outer bearing.
3. You should now be able to slide the hub/drum assembly off the spindle. If you have trouble removing this assembly you may need to retract the brake shoes by inserting a flathead screwdriver into the adjustment slot in the drum brake backing plate. Use the screwdriver to disengage the adjusting lever from the adjusting screw. You should now be able to turn the adjusting screw to retract the brake shoes.
4. Before you remove the drum brake backing plate you will want to remove all brake fluid from your brake system. ***Be very careful not spill any brake fluid on any painted surfaces as it will damage your paint.*** To remove the brake fluid from your system first remove the lid from your master cylinder. Next place one end of a clear hose on the bleeder of your wheel cylinder and the other into a suitable container. Finally open the bleeder screw until all fluid has been removed from your system
5. From under the dash disconnect the pushrod from the pedal assembly.
6. Disconnect the brake line(s) from your master cylinder. Remove the retaining hardware and remove the master cylinder and or power booster from the firewall. This assembly will also include the pushrod that was previously disconnected from the pedal.
7. Disconnect the hard brake line from your flexible hose at the frame rail. Use a tube wrench as to not damage the brake line fittings. If your fittings look rusty spray them with penetrating oil and let them soak for easy removal.
8. Remove the horseshoe clip from the brake hose at the frame mount.

Spindle Assembly Removal:

1. Remove outer tie rod end retaining pin and nut. Carefully remove tie rods with the use of a splitter or "pickle fork" tool.
2. In order to remove the spindles the coil springs must be compressed. Place a floor jack directly under the coil spring pocket of the lower control arm and jack up the control arm to compress the spring. Make sure the frame rail of the vehicle is still supported by the jack stand. To insure the jack stays in place and the spring remains compressed a heavy duty safety chain should be run over the frame rail and secured to the frame of the floor jack.

3. With the spring compressed and the safety chain secured remove the cotter pins and locknuts from both the upper and lower ball joints. Carefully separate the ball joints from the spindles using the splitter or "pickle fork" tool.
4. Remove spindles from the vehicle. Separate the steering arms from the spindle assembly and save for re-installation.

Inspection:

Check all ball joints and tie rods for wear or damage prior to reassembly. Any worn or damaged parts should be replaced before you proceed.

Steering Arms:

Some GM vehicles used 7/16" holes in the steering arms from the factory. If your steering arms have 7/16" holes you will need to drill them out to fit the 1/2" bolts supplied in the kit.

Brake Kit Installation:

1. Install new spindles onto the upper and lower ball joints with the original castle nuts. After you torque the upper ball joint to 50 ft lbs and the lower ball joint to 65 ft lbs install new cotter pins.
2. With the spindles installed and the nuts torqued the safety chain and floor jack can be removed.
3. Install **Caliper mounting brackets** so that the bracket ears are facing outward and the caliper opening is facing the rear of the vehicle.
4. Install the **splash shield** on top of the mounting bracket so that the opening for the caliper faces the rear of the car. Install the supplied **5/8" bolt** at the top of the spindle through the bracket and shield. **Photo 2**
5. Using the **1/2" bolts and nuts** supplied install the steering arms on the inboard side of the spindle. Install the bolts so the heads are on the outboard side of the spindle. Make sure the steering arms are oriented correctly to attach to the tie rod ends. The **longer 1/2" bolt** will be used on the hole closest to the rear of the vehicle and it will also pass through the splash shield and mounting bracket. The **shorter 1/2" bolt** will be used on the hold towards the front of the vehicle.
6. Torque the **5/8" bolt** to 100 ft lbs and torque the **1/2 bolts** to 75 ft lbs.
7. Reinstall tie rods and locking nuts, torque to 35 ft lbs and install new cotter pin.
8. Next you will need to properly pack the **inner and outer bearings** with grease prior to installation.
9. Remove the protective coating from your **rotors** on both the braking surface and bearing race surfaces using a brake cleaner available at your local parts store.
10. Grease the inner bearing race and install the greased **inner bearing** into the **rotor**. **Photo 3**
11. Lightly pack grease into the inner lip of the **grease seal**. Next install the **grease seal** into the inner portion of the **rotor** using a soft mallet or piece of wood. This will prevent any damage from occurring during installation. * **The lip of the seal should face the bearing when installed.**
Photo 4

12. Slide the **rotor** onto the **spindle** grease the outer bearing race and install the greased **outer bearing, slotted washer** and **adjusting nut**. **Photo 5 and 6**
 - a. **Adjustment nut installation VERY IMPORTANT.** Rotate the rotor while tightening the spindle nut to 18-24 ft lbs. Next back off the adjustment nut about 1/2 turn and retighten to 10-15 ft lbs while aligning the retaining slots with the cotter pin hole in the spindle.
 - b. Install **cotter pin**, bend cotter pin so that each side is bent in the opposite direction of the other.
 - c. Install the **grease cap**. **Photo 7**
 - d. Spin the rotor to insure there is no interference with the grease cap and retaining assembly.
13. **Calipers** should arrive preloaded, if they are not you must install the brake pads so that the friction material is facing each other. The **inner brake pad** will require the pad retaining clip to be installed on the back of the brake pad then slid into the piston. **Photo 8, 9, 10 and 11.**
14. The **outer brake pad** will need to fit snugly into the caliper. To do this you must bend the upper tabs down until a snug fit is accomplished. **Photo 12**
15. Lubricate supplied caliper mounting pins with silicone grease.
16. Install the **calipers** with the bleeder screw facing up. Install the supplied **slider bolts** thru the inner caliper ears, then thru the bracket and finally into the outer caliper ear. Torque to 25-30 ft. lbs. Make sure that the slider bolt passes thru the underside of the inboard pad guide when installed. **Photo 13 and 14**
17. Once the calipers are installed spin the rotors to insure there is no interference between the caliper and the rotor.
18. Attach the flexible brake lines to the caliper using the banjo bolt and copper washers provided in the kit. Place one copper washer on the banjo bolt and then slide the banjo bolt into the flex hose. Install a second copper washer onto the end of the bolt and then install the bolt into the caliper. Tighten the banjo bolts to 25 Ft/Lbs. Additional torque may be required if any leaks are noted after bleeding the brakes. **Photo 15**
19. Install the other end of the flex hose to the frame bracket using the **horseshoe clip** provided. Reconnect the original hard line and tighten using a tube wrench.
20. Turn the wheels thru a complete left and right turn to insure there is no interference with the new brake system and any suspension or body components. Also check the rubber hoses during this operation to insure the hoses are not binding or twisting. If your rubber hoses bind during a turn you could experience loss of braking while driving. If it looks like they are binding remove the horseshoe clip and reposition the brake hose until it no longer binds.
21. Please remember you will need to have a professional front end alignment performed to insure your car drives correctly. Failure to do so will result in poor handling and tire wear. The alignment should be set to the factory specs for your particular year make and model.

Brake Line And Proportioning Valve Installation

1. If you have ordered a kit with the combination valve you will need to remove your factory valve and master cylinder lines. The new valve can then be connected in the reverse manner. This may require re-bending of the original lines to connect to the new valve. Please refer to the diagram included in your instruction packet for proper connections. Be sure to connect your brake warning switch to the new valve using the supplied pigtail if needed.
2. If you ordered a kit with the adjustable style proportioning valve your factory combination valve can be retained. Install the supplied brass fittings into the ports of the adjustable proportioning valve.
3. Disconnect the line from the factory distribution block that goes out to the rear brakes. Connect that line to the **Out** port of the adjustable proportioning valve. You will then need to install a line between the factory distribution block and the adjustable proportioning valve. An alternate method would be to cut a section out of the rear brake line after the factory distribution block and flare new end onto the line to make room for the adjustable valve. This allows the valve to be mounted anywhere between the factory block and the rear flex line.

Power Booster Installation:

1. Install the **original** clevis from your factory pushrod onto the power booster, do not lock it into position yet as adjustments will need to be made later.
2. With the booster **check valve positioned** in the upper RH corner, install the power booster **mounting brackets** so that the longer leg of the bracket is against the booster and the short leg of the bracket is offset towards the bottom of the booster.
3. Secure power booster to firewall using the original mounting bolts. These bolts may be difficult to tighten with the limited space available. All 4 bolts can be accessed using a standard wrench.
4. From under the dash **adjust the pushrod** to meet the pedal in its original position. Note the pushrod must be connected to the lower hole in the pedal when installing power brakes. Once the pushrod has met the desired length, secure the **locking nut** to the pushrod.
5. Install original pushrod locking mechanism to secure the pushrod to the pedal.
6. Check the adjustment on the brake light switch to insure the tail lights cycle on and off correctly as the pedal is applied.
7. Using the supplied **vacuum hose** connect the power booster to a direct source of engine manifold vacuum or aftermarket vacuum pump.

Master Cylinder Bench Bleeding

1. Before you install your master cylinder you must **bench bleed** it in a vice off of the vehicle using the **bench bleeder kit** provided.
2. To Bench Bleed
 - a. Place your master cylinder in a **vice** by the mounting ears.
 - b. Attach a clear plastic hose to the short end of each of the plastic nozzles provided.

- c. Clip the plastic bridge onto the partition wall of the master cylinder and insert each plastic tube into the holes insuring the end of the tube will be fully submerged in the brake fluid.
- d. Press the tapered end of the nozzles firmly into the master cylinder ports with a twisting motion.
- e. Fill the reservoir with new clean brake fluid (DOT 3 or DOT 4 Recommended).
- f. Using a large Phillips head screwdriver push the piston in, then release using full strokes. This MUST be done until ALL air has disappeared from the clear plastic hoses.

CAUTION- MASTER CYLINDER WILL NOT BLEED PROPERLY IF HOSES ARE NOT FULLY SUBMERGED IN BRAKE FLUID UNTIL THE BLEEDING PROCESS IS COMPLETE

Master Cylinder Install:

1. Remove the master cylinder from the vice and install on the power booster, secure with the supplied hardware. ***Be very careful not spill any brake fluid on any painted surfaces as it will damage your paint.***
2. Carefully remove the bleeder kit nozzles and install the brake lines in the appropriate ports.
3. If you ordered a kit with the combination valve the lines are already bent and oriented to easily connect to the master cylinder. If you ordered a kit with the adjustable style proportioning valve minor bending of the original lines may be required.
4. Secure all brake lines and check for leaks.

Bleeding the vehicles braking system:

We recommend that the brake system is bled using a gravity bleed method. While there are many ways to bleed a system this way is less likely to introduce air in the system causing a spongy pedal. Whenever bleeding your system you must keep an eye on your fluid level. If your master runs dry you will have to bench bleed the master again.

1. Remove the cap from the master cylinder.
2. Starting at the right rear wheel cylinder or caliper attach a clear hose to the bleeder with the other end in a clear container.
3. Open the bleeder and observe the fluid flow. It may take a couple of minutes for the fluid to flow with a new system. Once the fluid begins to flow let it drip until you do not see any air.
4. Move to the left rear wheel, repeat step 3.
5. Move to the right front wheel, repeat step 3.
6. Move to the left front wheel, repeat step 3.
7. Repeat steps 2 thru 6 once more.
8. Install the lid on the master cylinder.
9. Pump the brake pedal until you achieve a firm pedal.

10. Remove lid on master cylinder & check fluid level
11. Repeat steps 2 thru 6 to insure all air has been removed.

Adjustable Proportioning Valve Adjustment

1. If you ordered your kit with the factory style combination valve it is not adjustable and this step can be skipped.
2. The adjustable proportioning valve is meant to control rear brake lockup by limiting the pressure to the rear brakes. If the rear brakes lockup prematurely the car can be difficult to control during a hard stop.
3. The valve provides a maximum of a 55% reduction in rear brake pressure. Meaning that even when adjusted to the full decrease position it will not shut off the rear brakes. Count the turns from the full decrease position to the full increase position. Turn the knob back in the full decrease direction half that number of turns. This will give you a good starting point for most vehicles.
4. Once you are confident that the brakes are fully bleed, working properly and broken in you can make several stops in a safe open area to determine your ideal setting. The goal is to provide as much pressure as possible to the rear brakes without locking them up prior to the front brakes.

Once you feel you have successfully removed all air from your brake system check all fittings and lines for leaks and verify all fasteners are tight. Install your wheels, and spin them to insure they still spin freely making sure the caliper doesn't interfere with the wheel and your brakes are not dragging or locked up.

You may now take your vehicle for a test drive in a safe area. We recommend that you drive the vehicle with light to medium application of the brakes for the first 150-200 miles. This will allow your brake pads to properly seat to your rotors to insure optimal braking performance.

If you have any questions please call our tech line at (716) 852-2139

Thank you for purchasing from Leed Brakes we hope you have had an enjoyable experience.

To brake warning light

In from master cylinder *front* brake port
1/2-20 fitting used

Out to front brake caliper (either
LH or RH side)
3/8-24 fitting used

In from master cylinder *rear* brake port
7/16-24 fitting used

Out to front brake caliper (either LH or RH side)
3/8-24 fitting used

Out to rear brakes
9/16-18 fitting used

LEED

INS0003

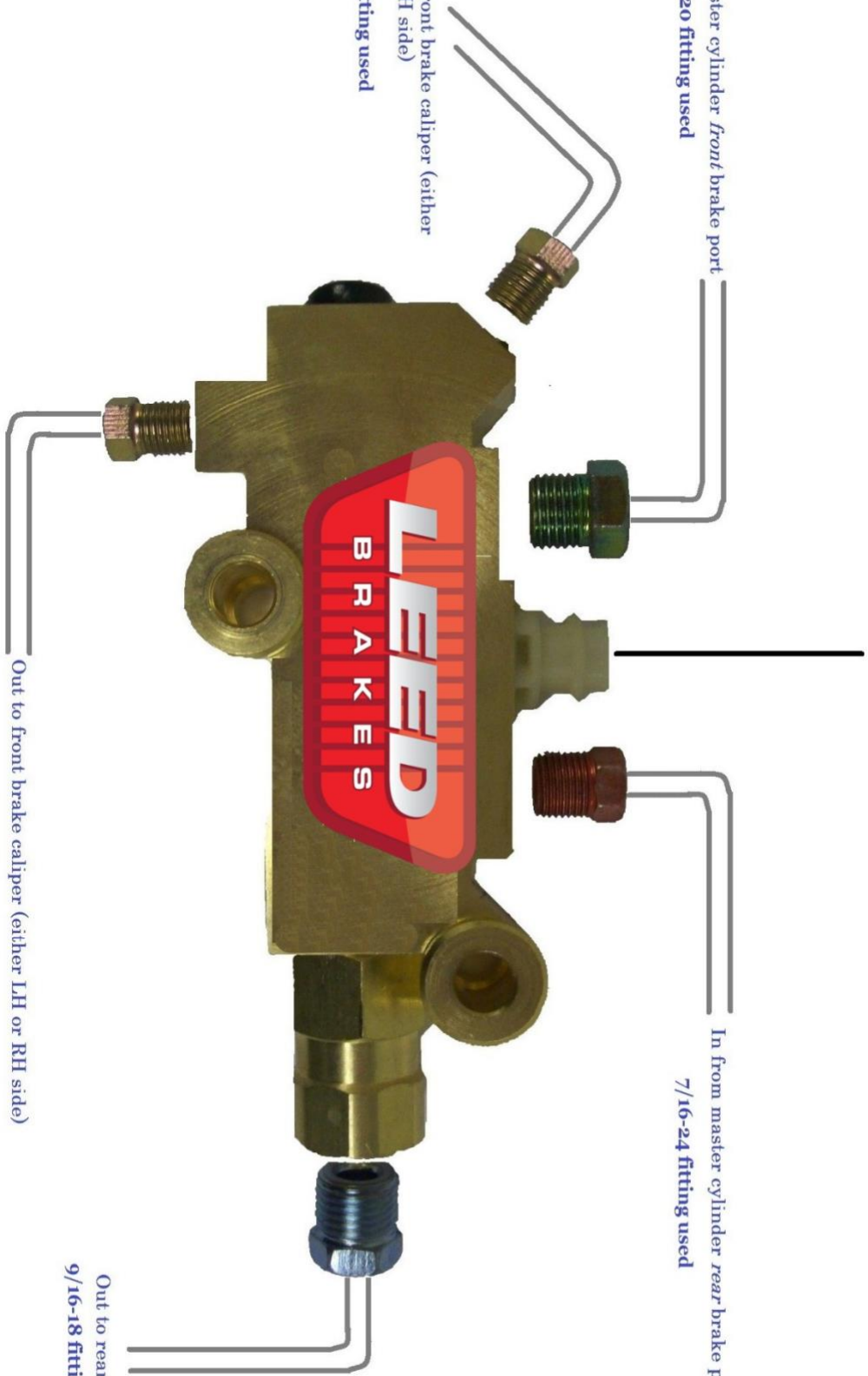



Installation Photos

Disc Brake Conversion Kit

Applications: 64-72 A- Body, 67-69 F-Body, 68-74 X-Body, 62-67 Nova



Photo 1

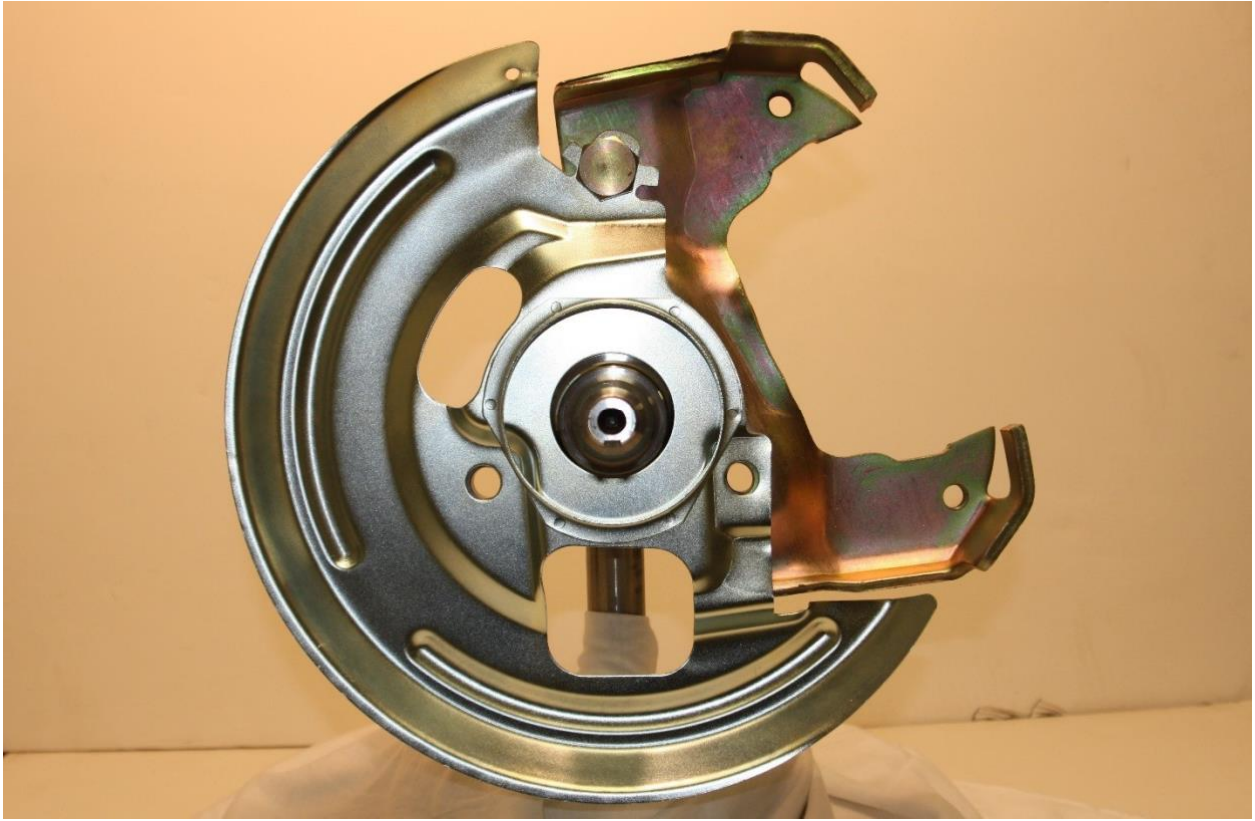

← Front Of Car

Photo 2



Photo 3



Photo 4



Photo 5



Photo 6



Photo 7

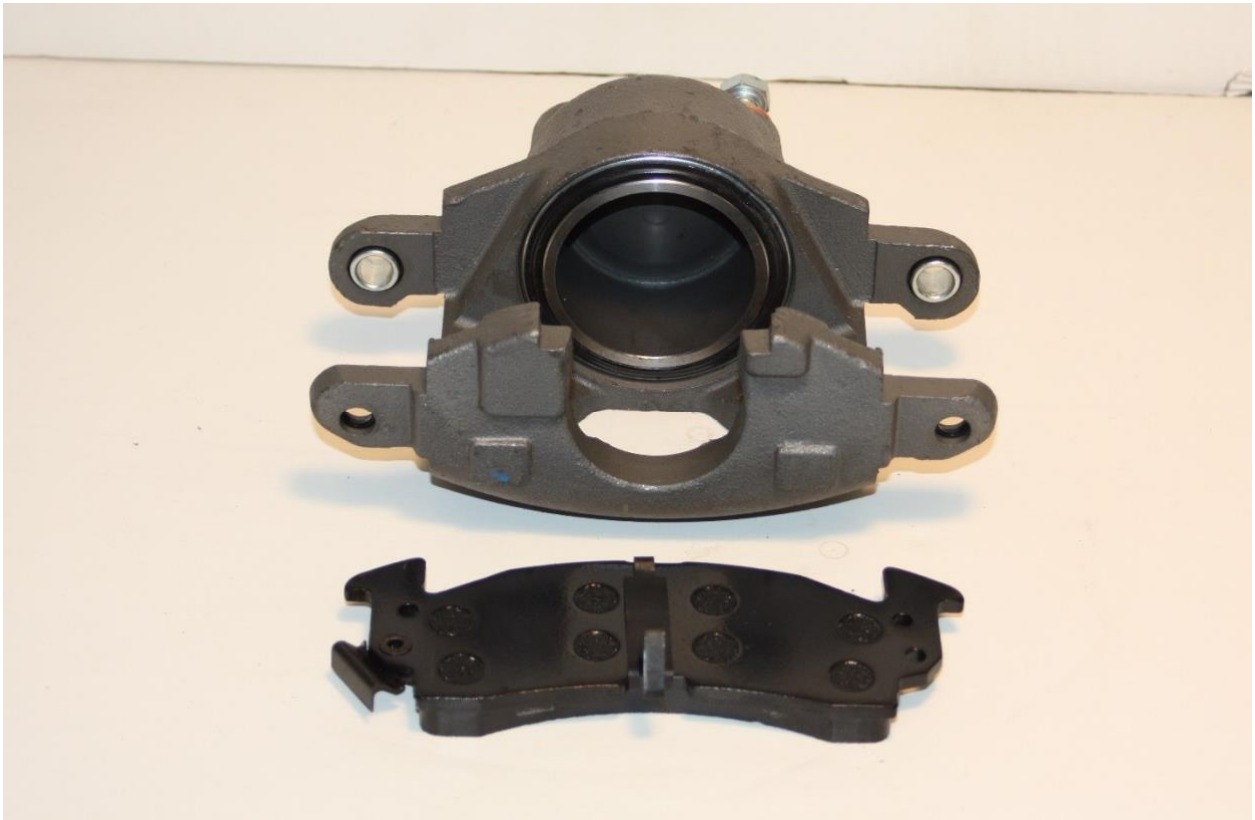

Photo 8

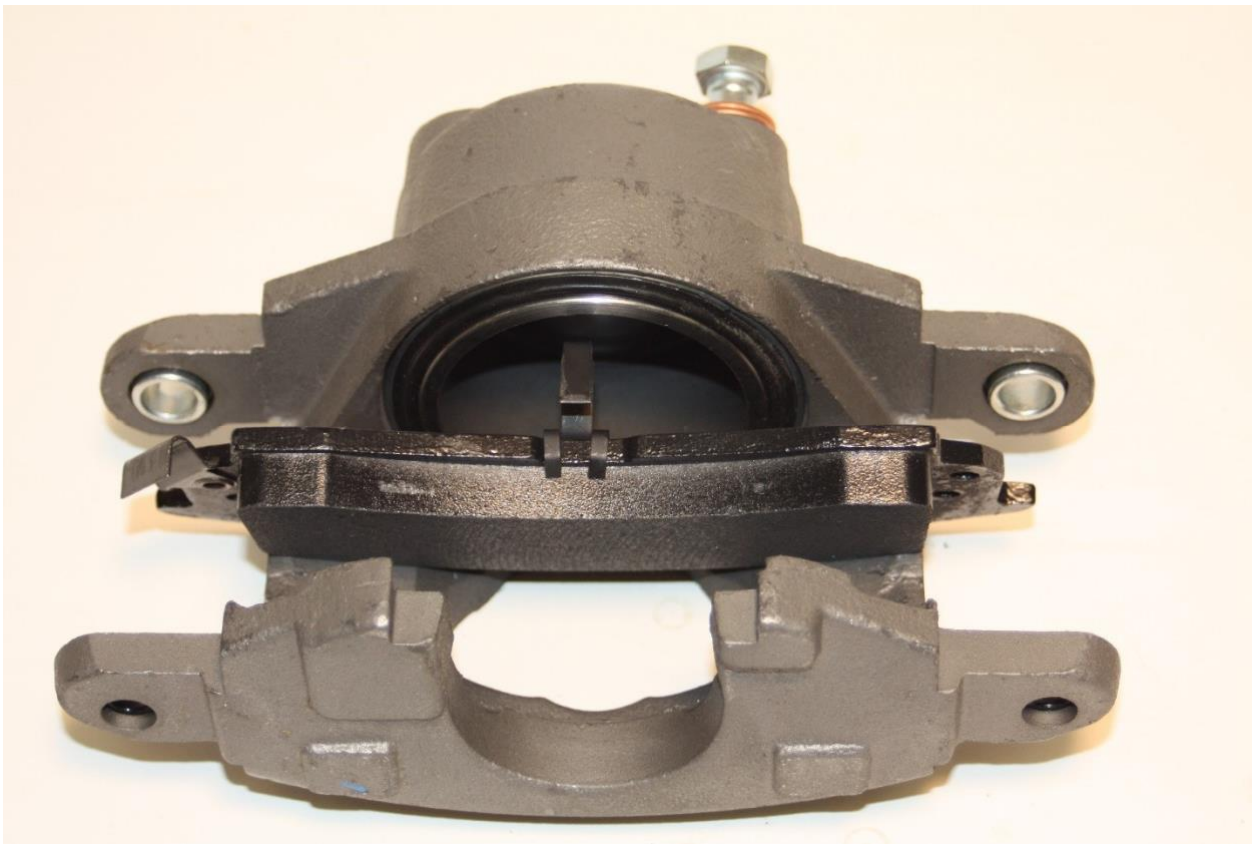

Photo 9

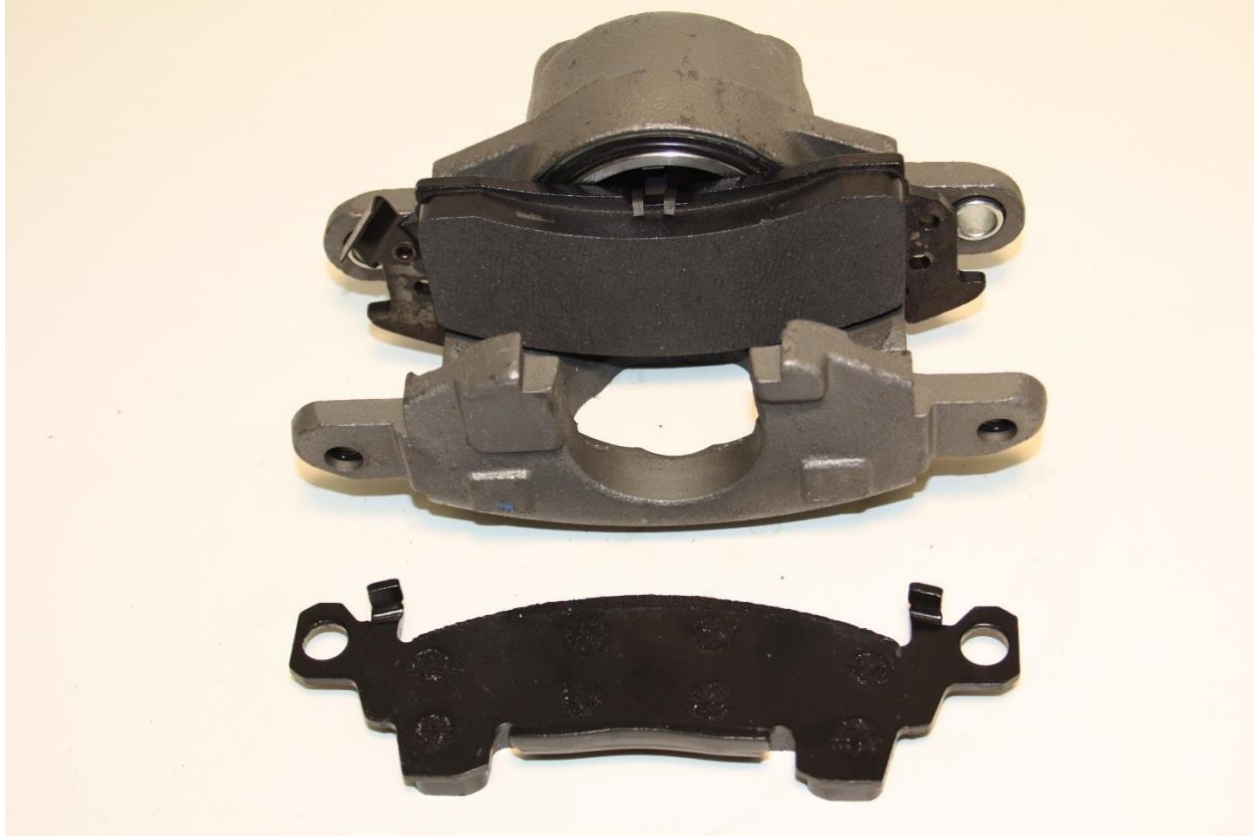

Photo 10

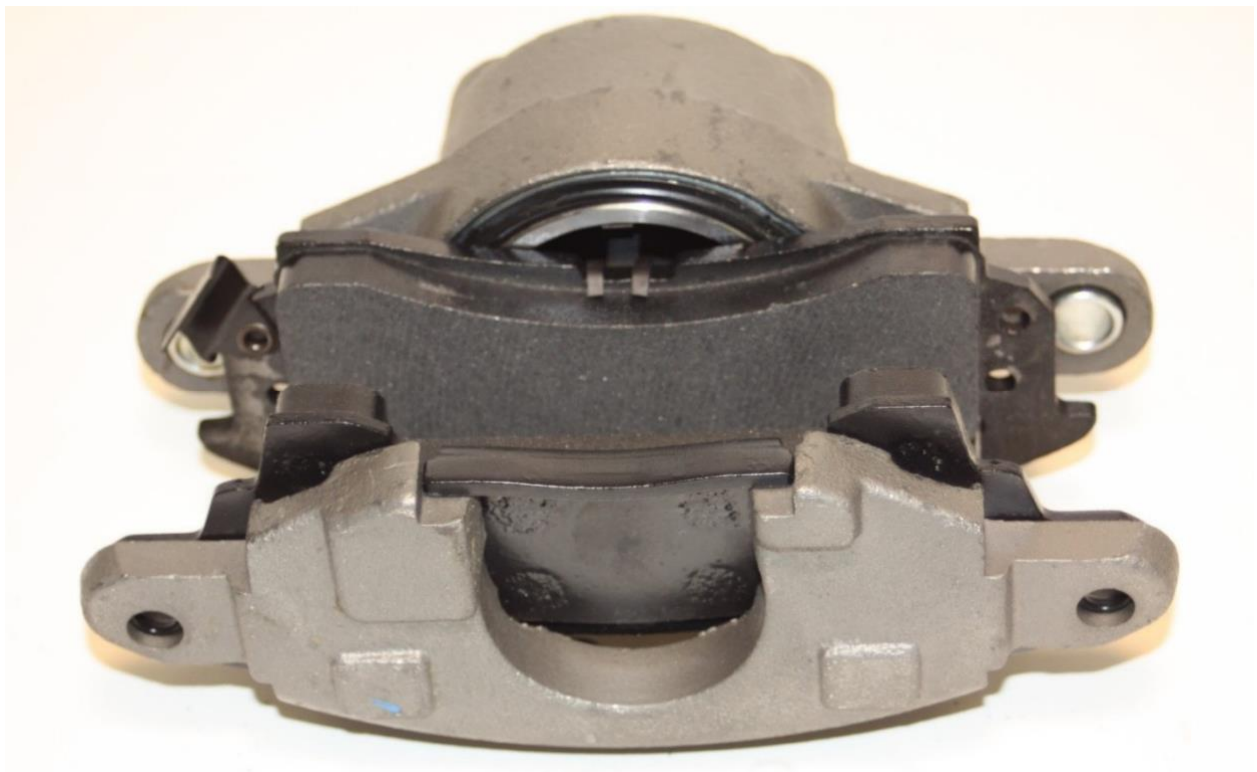

Photo 11



Photo 12



←Front Of Car

Photo 13

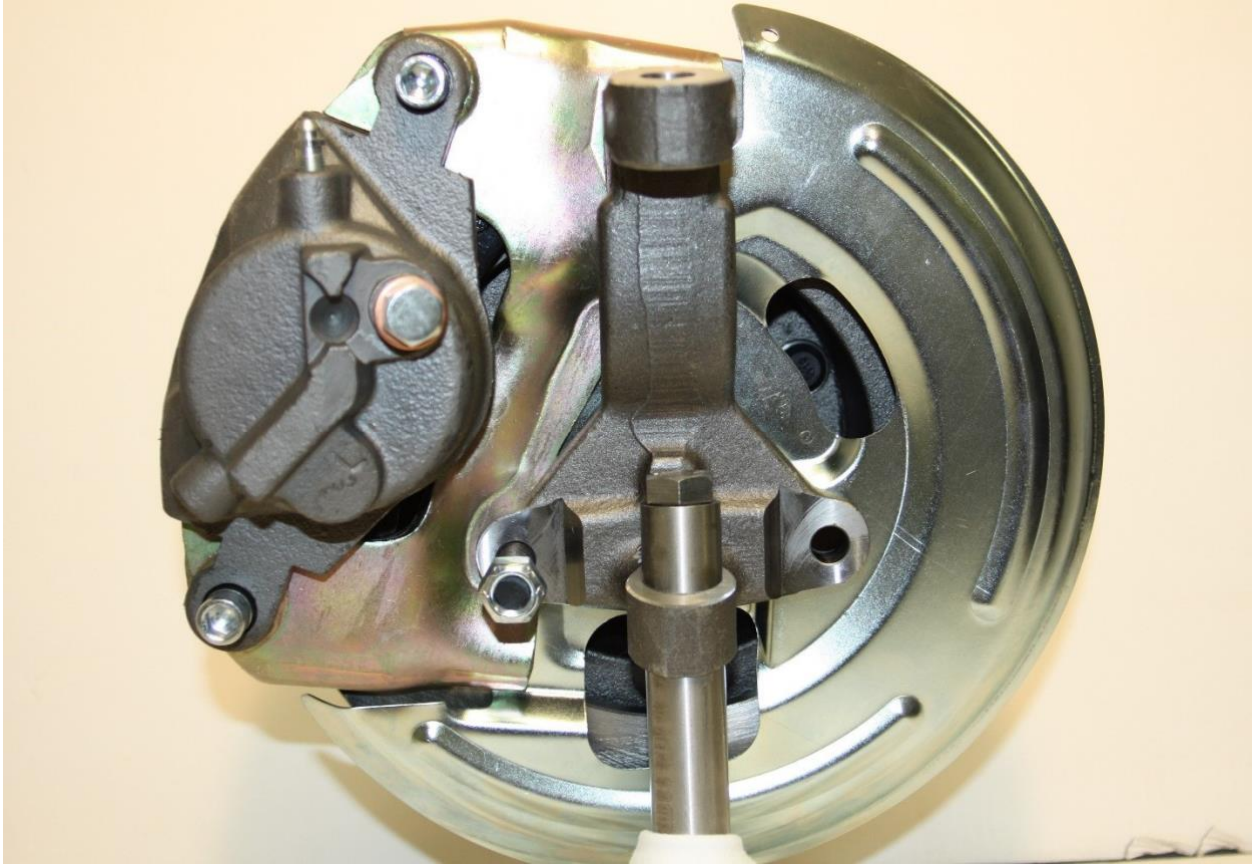

Photo 14



Photo 15

