

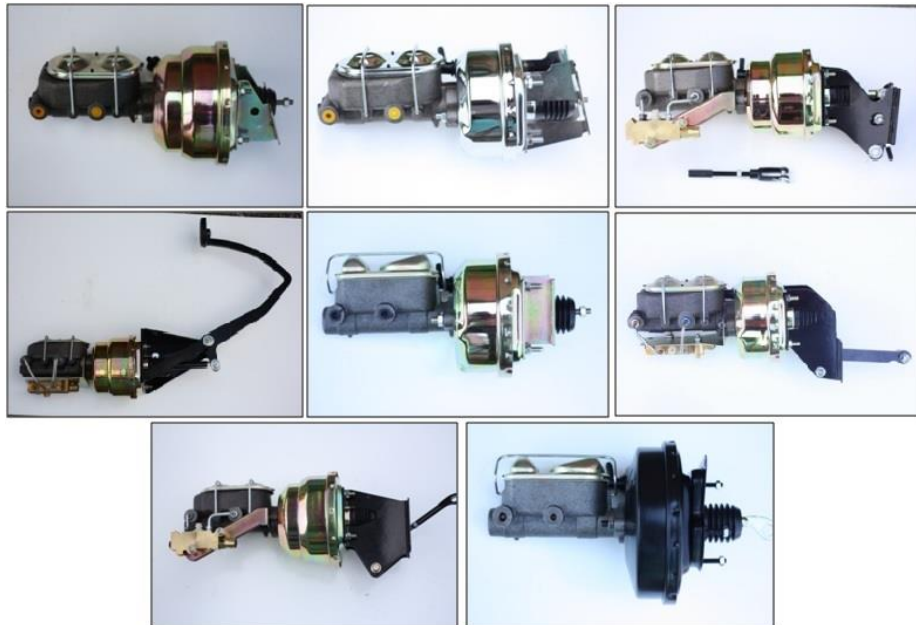

www.gpsbrakes.com

Installation Instructions

Power Kit Assembly Instructions



Thank you for choosing GPS Auto for your automotive product needs. Before you begin your installation please inspect all parts immediately and contact our customer service team at 716-852-2139 if you have any missing or damaged or incorrect parts.

Please take the time to review these installation instructions prior to disassembly of your current brake system to insure a smooth installation. If you have any questions regarding your installation please call our customer service team at 716-852-2139

Tools required for a safe and smooth installation:

Proper Jack & Jack Stands, Tube Wrenches, Standard Socket Set, Standard Wrench Set, Torque Wrench, Lug Wrench, Pliers, Mallet, Brake Fluid, Brake Cleaner.

Fitment Notes:

This is an all inclusive power booster assembly instruction set. Some parts of the instructions may not apply to you purchase. All steps in highlighted in green with the word (ALL) in the title apply to all applications. Certain applications have specific steps that you will see outlined in this document. If you have any questions regarding your installation please call us at 716-852-2139. Thank you for choosing GPS Automotive for your braking needs.

Vehicle Prep (ALL) :

1. Safely raise the vehicle off the ground until the wheels are clear and spin freely. Support the vehicle using the appropriate Jack Stands.
2. Remove all 4 wheels for easy access to the bleeders on your calipers & wheel cylinders.
3. From under the dash remove the pushrod from the pedal assembly.
4. Disconnect the brake line(s) from your master cylinder. ***Be very careful not spill any brake fluid on any painted surfaces as it will damage your paint.***
5. Remove all hardware retaining your current master cylinder or power booster to the firewall and remove from vehicle.

Power Booster Assembly (ALL) except 67-69 ford & Mopar see below

1. Install the **Threaded rod, coupler and clevis pin or pushrod assembly** onto the power booster, do not lock it into position yet as adjustments will need to be made later.
2. With the booster **check valve positioned** in the upper RH corner, install the power booster **mounting brackets** as shown in the appropriate picture on pages 5 & 6.
3. Secure power booster to firewall using the original mounting bolts. These bolts may be difficult to tighten with the limited space available. All bolts can be accessed using a standard wrench.
4. From under the dash **adjust the pushrod** to meet the pedal in its original position. Once the pushrod has met the desired length, secure the **locking nut** to the pushrod. Threaded rod may need to be cut shorter in some applications.
5. Install clevis pin and cotter pin.
6. Use a **11/32" vacuum hose** to connect the power booster to a direct source of engine manifold vacuum or aftermarket vacuum pump. In order for your power booster to function properly your vehicle must produce at least 17" of vacuum at idle.

Power Booster Assembly (67-69 Ford Car):

1. (If factory manual brake car) Remove manual brake pedal from vehicle and install new pedal as shown in **diagram 1A** on page 11 in this document.

2. Prepare the firewall by modifying the pushrod hole opening and drilling out the holes in the firewall as shown in **diagram 1B** on page 12 in this document.
3. With the booster **check valve positioned** in the upper RH corner, Secure power booster to firewall using the nuts provided. These bolts may be difficult to tighten with the limited space available under the dash. All bolts can be accessed using a standard wrench.
4. From under the dash install the pushrod onto the new brake pedal and secure with a new locking pin.
5. Use a **11/32" vacuum hose** to connect the power booster to a direct source of engine manifold vacuum or aftermarket vacuum pump. In order for your power booster to function properly your vehicle must produce at least 17" of vacuum at idle..

Power Booster Assembly (Mopar):

1. Prepare the firewall by modifying the pushrod hole opening and drilling out the holes in the firewall as shown in the diagram on page 13 in this document.
2. With the booster **check valve positioned** in the upper RH corner, Secure power booster to firewall using the factory hardware. These bolts may be difficult to tighten with the limited space available under the dash. All bolts can be accessed using a standard wrench.
3. From under the dash install the pushrod onto the new brake pedal and secure with a new locking pin.
4. Use a **11/32" vacuum hose** to connect the power booster to a direct source of engine manifold vacuum or aftermarket vacuum pump. In order for your power booster to function properly your vehicle must produce at least 17" of vacuum at idle..

Master Cylinder Prep (All)

1. Before you install your master cylinder you must **bench bleed** it in a vice off of the vehicle using the **bench bleeder kit** provided.
2. To Bench Bleed
 - a. Place your master cylinder in a **vice** by the mounting ears.
 - b. Attach a clear plastic hose to the short end of each of the plastic nozzles provided.
 - c. Clip the plastic bridge onto the partition wall of the master cylinder and insert each plastic tube into the holes insuring the end of the tube will be fully submerged in the brake fluid.
 - d. Press the tapered end of the nozzles firmly into the master cylinder ports with a twisting motion.
 - e. Fill the reservoir with new clean brake fluid (DOT 3 or DOT 4 Recommended).
 - f. Using a large Phillips head screwdriver push the piston in, then release using full strokes.
This MUST be done until ALL air has disappeared from the clear plastic hoses.

CAUTION- MASTER CYLINDER WILL NOT BLEED PROPERLY IF HOSES ARE NOT FULLY SUBMERGED IN BRAKE FLUID UNTIL THE BLEEDING PROCESS IS COMPLETE.

Master Cylinder Install (ALL)

1. Remove the master cylinder from the vice and install on the new power booster. ***Be very careful not spill any brake fluid on any painted surfaces as it will damage your paint.***
2. Install your brake lines from your original brake system to the new distribution block (if purchased) See pages 7,8,9 & 10 for brake line routing and fitting sizes.
3. If you did not purchase a distribution block please refer to page 6 to determine which master cylinder ports will be used for the front and rear brakes. Route your brake lines accordingly using your factory distribution block, tee and or adjustable valve. Refer to page 9 for typical brake line routing diagram.
4. Carefully remove the bleeder kit nozzles and install the brake lines in the appropriate ports.
5. Secure all brake lines and check for leaks.
6. Reinstall factory pushrod

Bleeding the vehicles braking system (ALL):

We recommend that the brake system is bled using a gravity bleed method. While there are many ways to bleed a system this way is less likely to introduce air in the system causing a spongy pedal. Whenever bleeding your system you must keep an eye on your fluid level. If your master runs dry you will have to bench bleed the master cylinder again.

1. Remove the cap from the master cylinder.
2. Starting at the right rear wheel cylinder or caliper attach a clear hose to the bleeder with the other end in a clear container.
3. Open the bleeder and observe the fluid flow. It may take a couple of minutes for the fluid to flow with a new system. Once the fluid begins to flow let it drip until you do not see any air then close the bleeder.
4. Move to the left rear wheel, repeat step 3.
5. Move to the right front wheel, repeat step 3.
6. Move to the left front wheel, repeat step 3.
7. Repeat steps 2 thru 6 once more.
8. Install the lid on the master cylinder.
9. Pump the brake pedal until you achieve a firm pedal.
10. Remove lid on master cylinder & check fluid level
11. Repeat steps 2 thru 6 once more to insure all air has been removed.

Once you feel you have successfully removed all air from your brake system you may install your wheels, and spin them to insure they still spin freely and your brakes are not dragging or locked up.

You may now take your vehicle for a test drive in a safe area. If you have installed new rotors, drums and/or brake pads it is recommended that you drive the vehicle with light to medium application of the brakes for the first 150-200 miles. This will allow your brake pads to properly seat to your rotors and/or drums with optimal braking performance.

The next few pages will be a guide to specific assemblies, components, line routing and technical information that may help you thru your installation.

That completes the installation of your Power Brake System. If you purchased a kit containing other disc brake components, please refer to the separate instructions provided with those components.

If you have any questions please call our tech line at 716-852-2139

Thank you for purchasing from GPS Automotive we hope you have had an enjoyable experience.

Power Booster & Master Cylinder assemblies by application

GM Car & Truck

GM 64-74 AFX BODY



55-68 GM Full Size Car & 60-66 C10 Truck

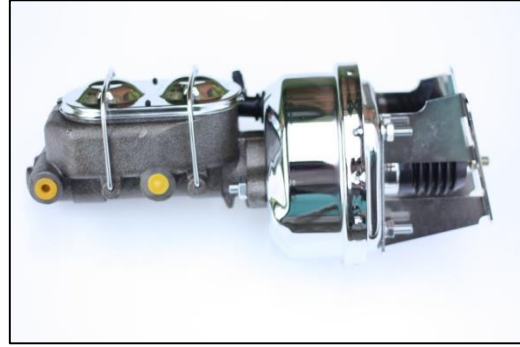

67-72 GM Truck

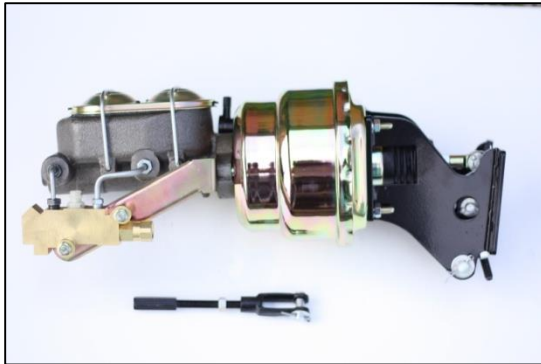

55-59 GM Truck



Ford Car & Truck Assemblies

63-66 Ford/Merc Passenger Car

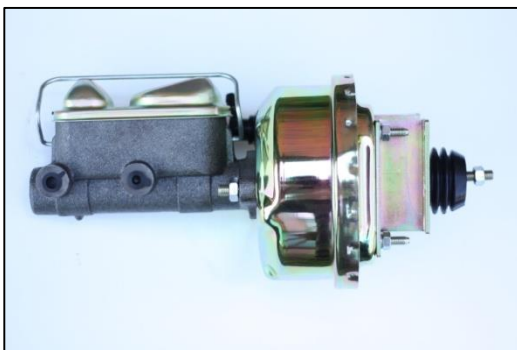

67-69 Ford/Merc Passenger Car

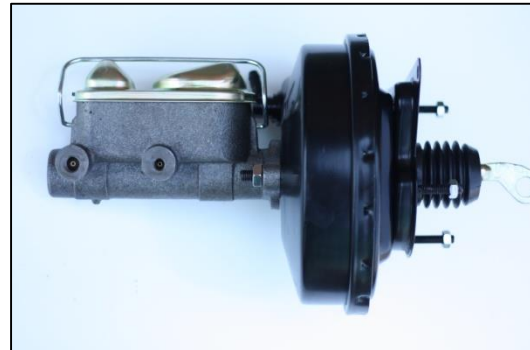

Ford Assemblies Continued

61-72 Ford Galaxy & 57-72 Ford Truck

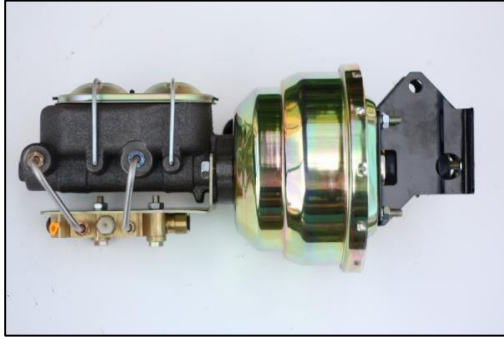

Jeep Assemblies

Jeep CJ Series Assembly



Mopar Assemblies

62-74 Mopar Assembly

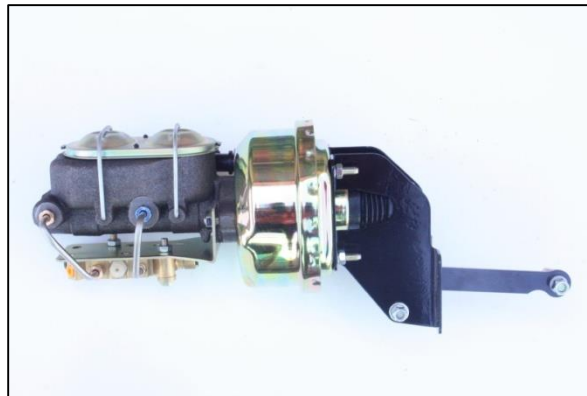

Master Cylinder Guide

Typical GM Style Master Cylinder



Front brake port - 1/2-20

Rear Brake port - 9/16-18

Typical Ford Style Master Cylinder

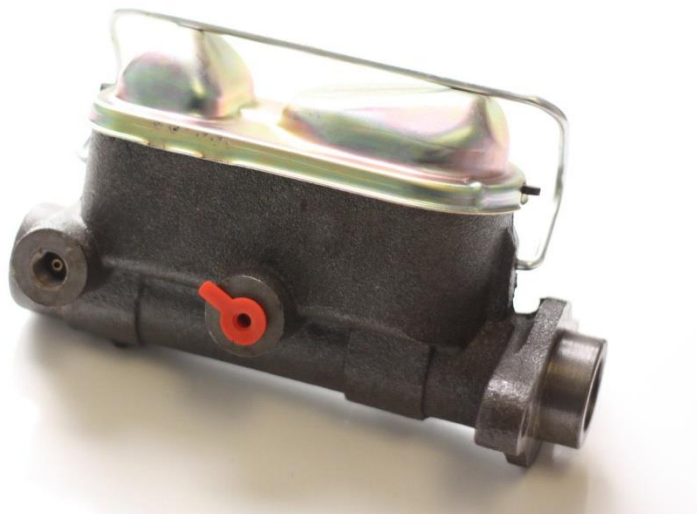

Front Brake port - 3/8-24

Rear Brake Port - 1/2-20

GM Master Cylinder Proportioning Valve Install

Bottom Mount

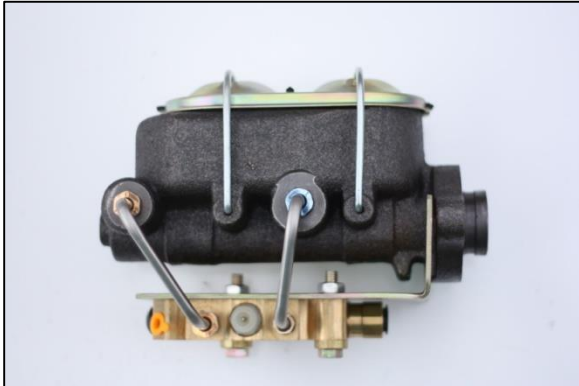

Side Mount



Ford Master Cylinder Proportioning Valve Install

Bottom Mount



Distribution Block fitting and brake line routing guide

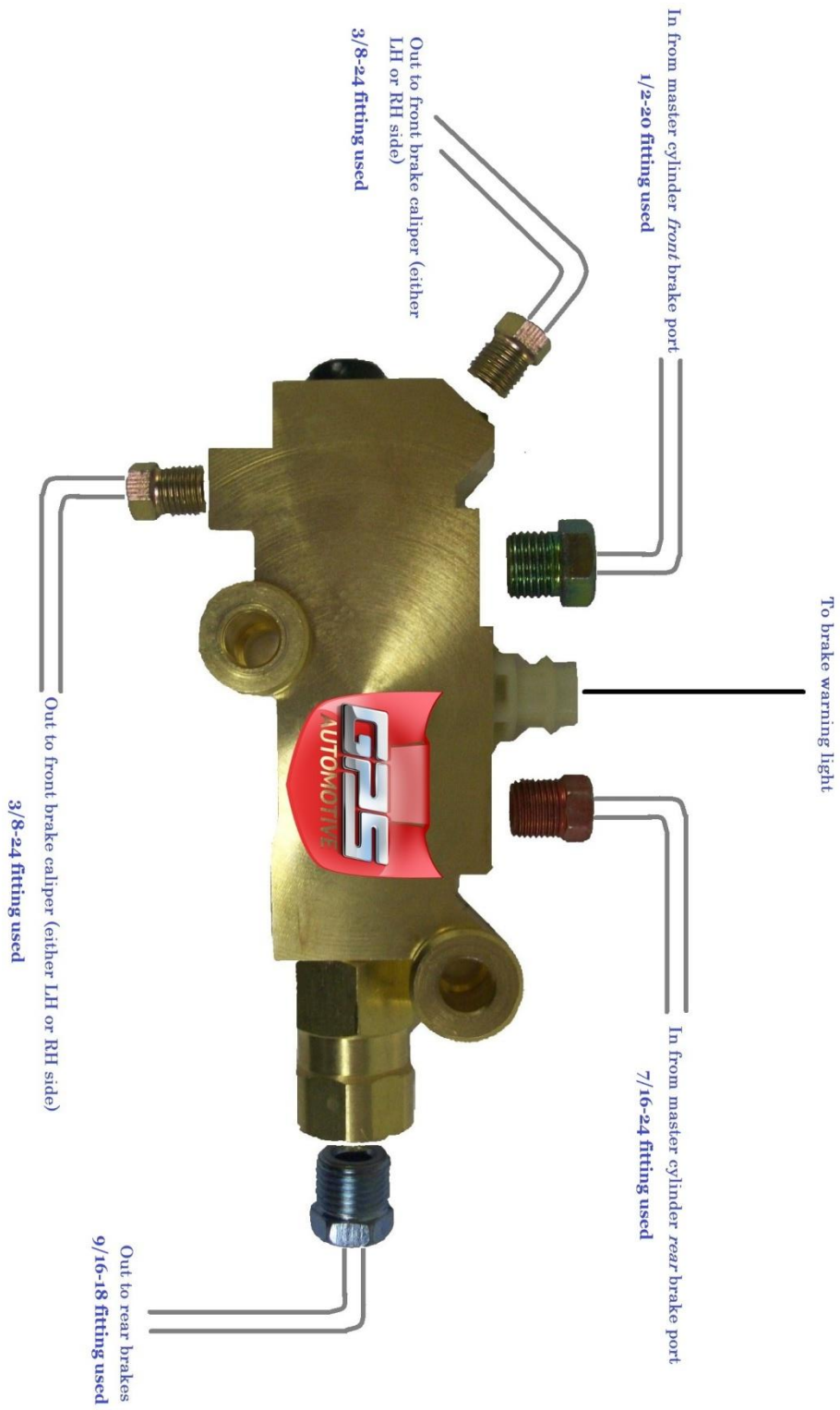

Typical Brake Line Routing

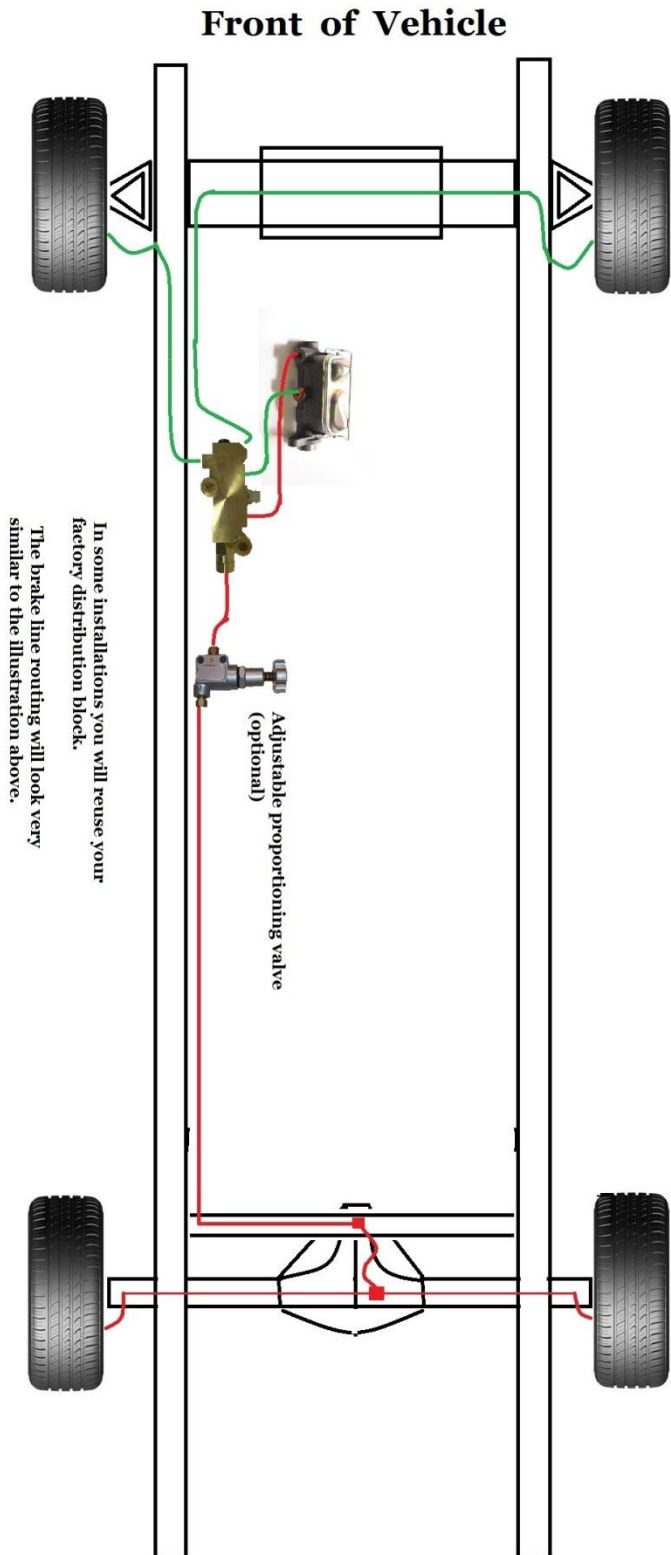

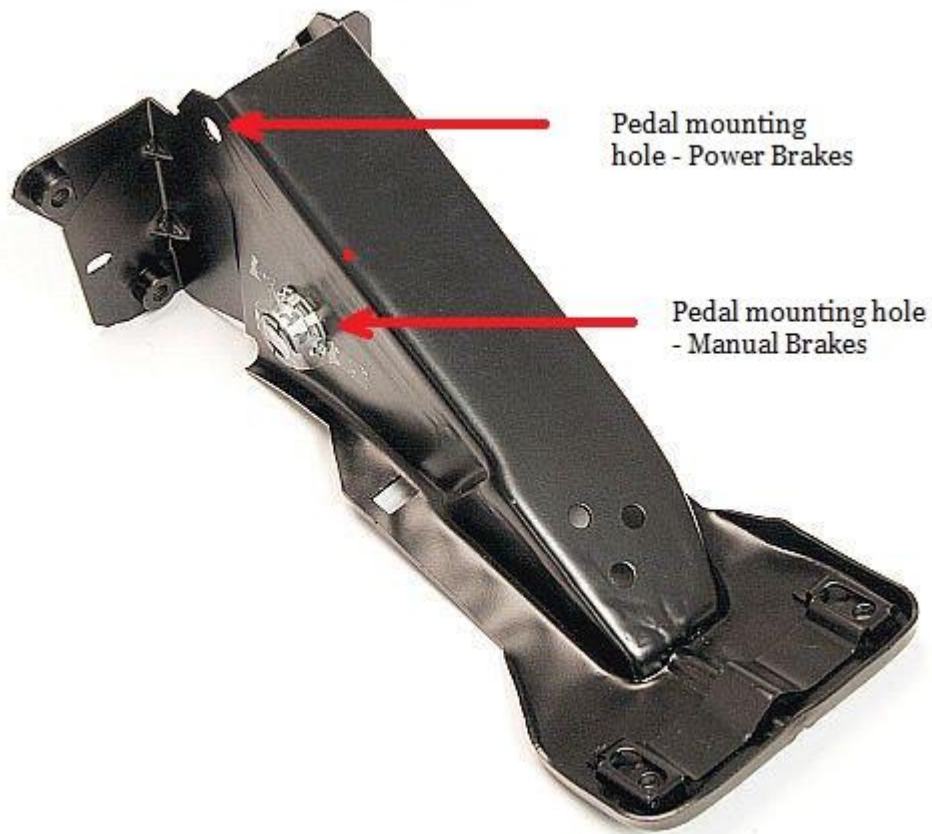

The Ford factory brake pedal support contains two mounting positions for both the original manual brake pedal and the power brake pedal. The new power brake pedal will mount in the upper hole located closest to the firewall. This position ensures proper leverage to actuate your brake system with comfortable pedal pressure.

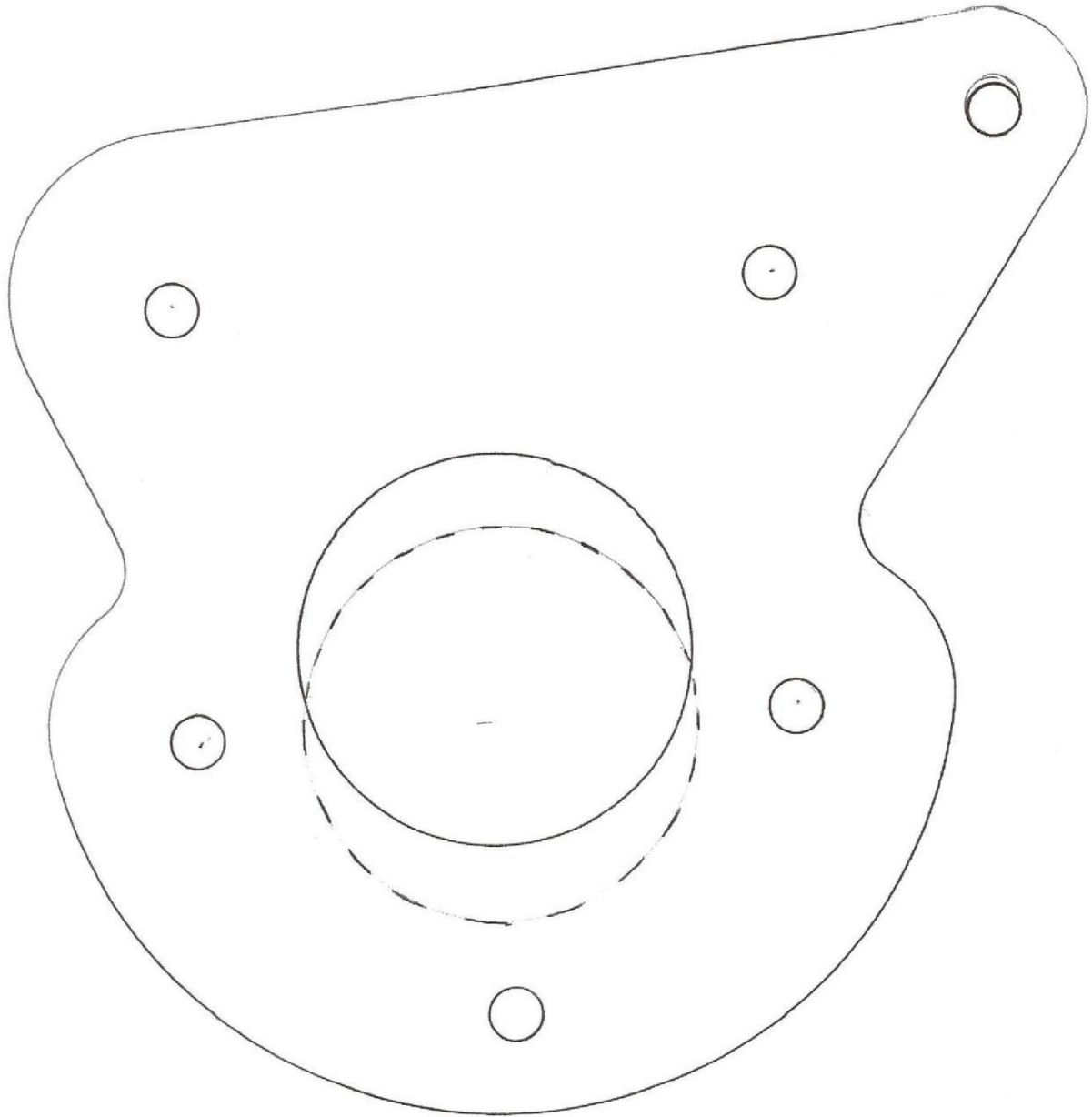

The Dotted line above represents the original hole in your firewall if your vehicle was equipped with manual brakes. The solid circle represents the area that must be trimmed to fit your new power booster.

Mopar Power Brake Booster Installation Guide

When installing power brakes onto a vehicle equipped with factory Power brakes some modifications of the firewall are required. The lower 4 holes in the diagram below are the original mounting studs for the factory master cylinder. In order to use this power booster you will need to cut the firewall into the shape shown in the dotted lines below. The other option is to purchase a firewall plate for a factory manual brake car. If your vehicle was a factory manual car no modifications are necessary as this section was cut out by the factory.

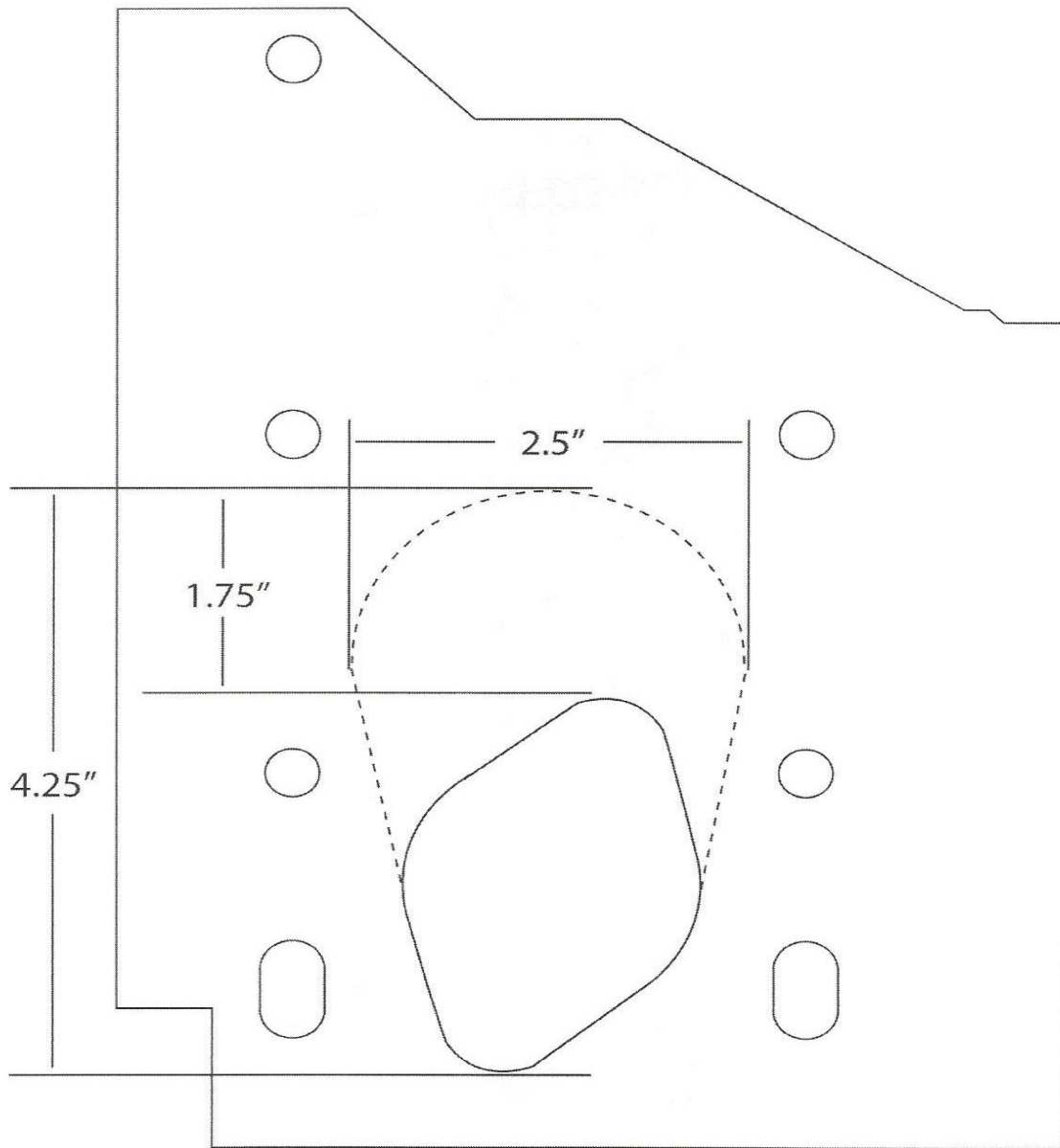

Adjustable Proportioning Valve Instructions



Installation – The proportioning valve is intended to be installed in the rear fluid line after any factory style distribution block. An adjustable proportioning valve should never be installed between the master cylinder and distribution block as the block will sense unequal pressure and block fluid flow.

Use only the two .25" holes in the valve body to secure the valve to a mount. The two ports have 3/8-24 inverted flare fittings to adapt double flared hard brake lines directly to the valve.

Connect the "IN" port to the brake line coming from the master cylinder or distribution block. Connect the line going to the rear calipers to the "OUT" port.

Adjustments - The adjusting knob is marked with an arrow indicating the direction required to decrease line pressure to the calipers. The knob rotated all the way out in a counter-clockwise direction will provide a maximum pressure reduction of 55%. Rotating the knob in a clockwise direction will increase line pressure, up to the full pressure that your system allows.

TESTING THE SYSTEM - Do not attempt to operate the vehicle until the system has been fully tested under controlled conditions in a safe location. After the system has been bled, checked for leaks, and the proper pedal travel has been determined, make a series of low speed stops, then gradually progress to normal operating speeds.

